

L型水路

H = 1000

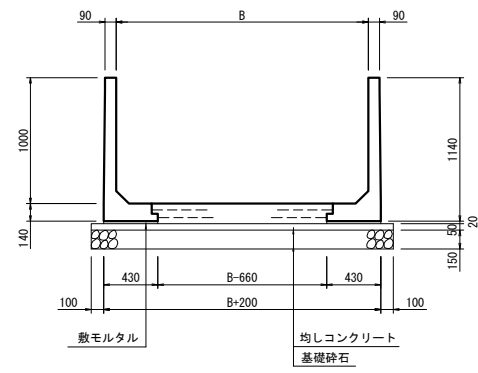

H = 1100

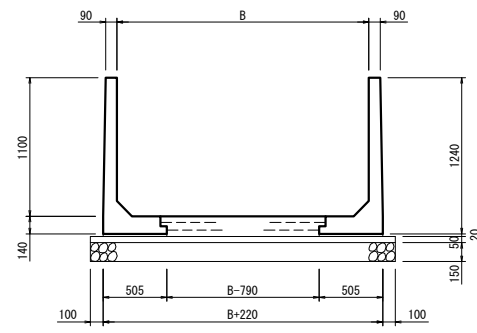

H = 1200

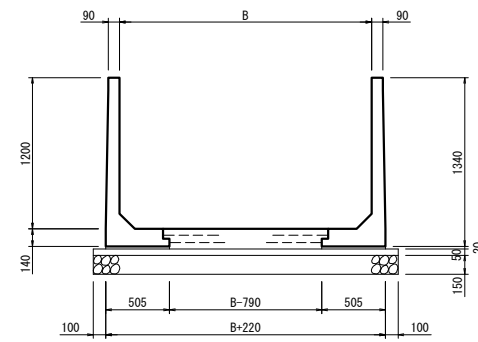

H = 1300

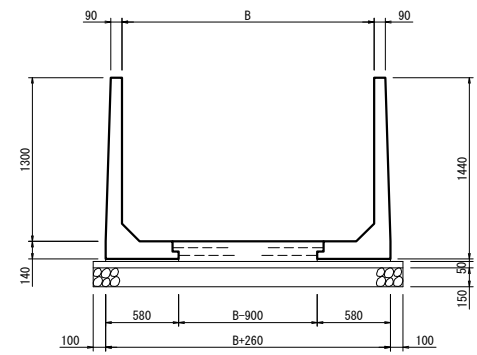

H = 1400

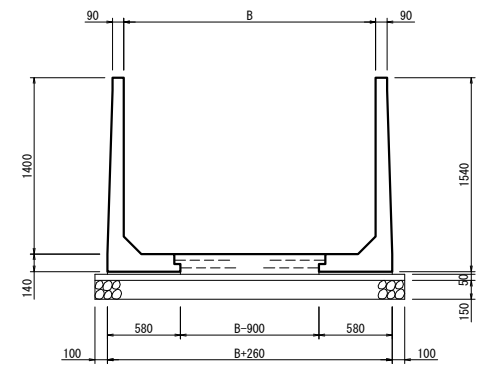

H = 1500

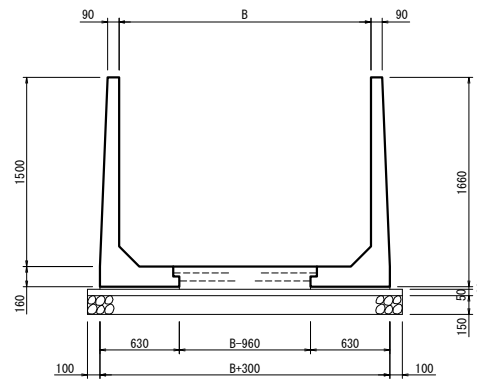

H = 1600

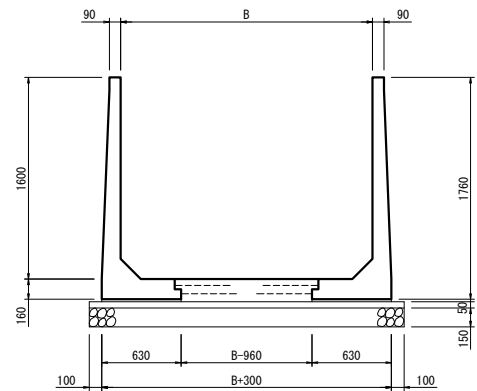

H = 1700

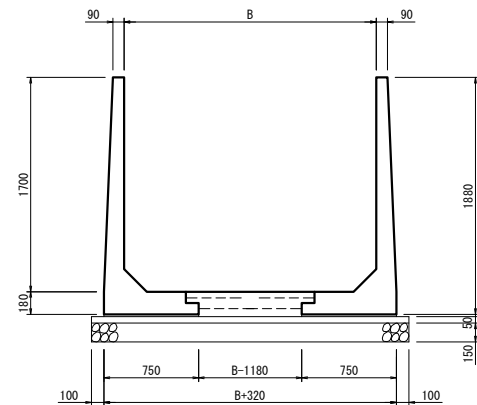

H = 1800

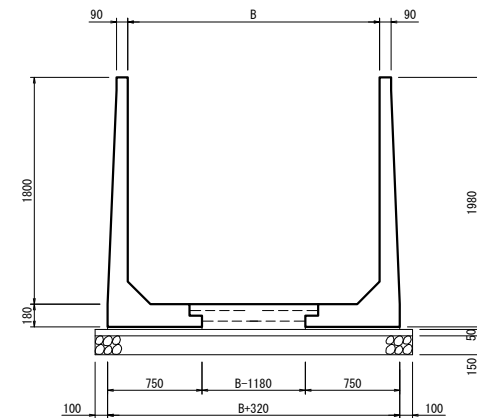

H = 1900

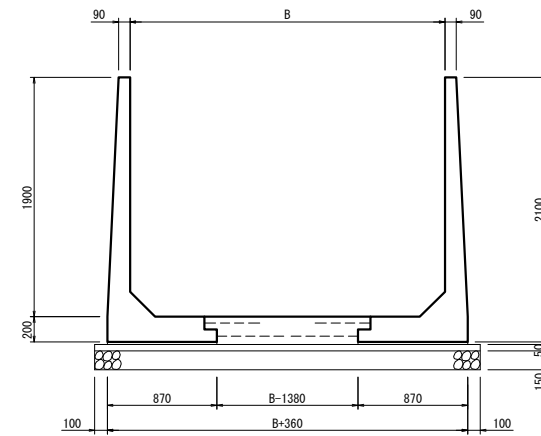

H = 2000

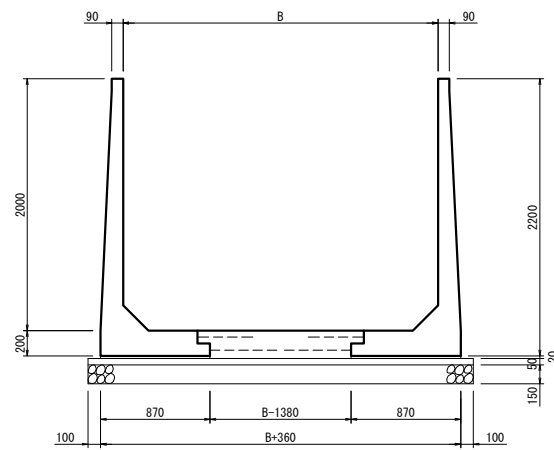

H = 2100

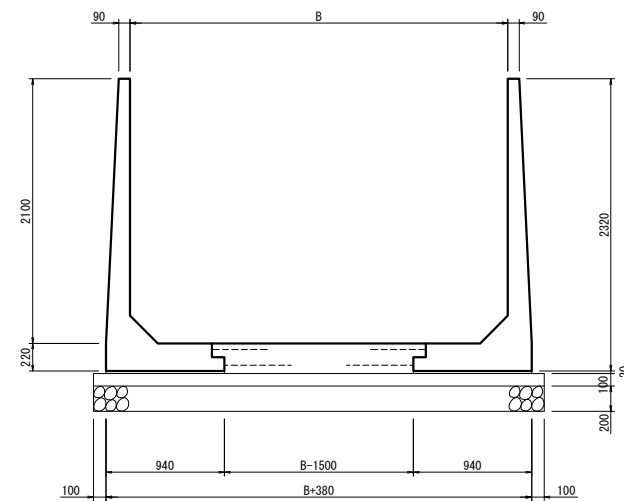

H = 2200

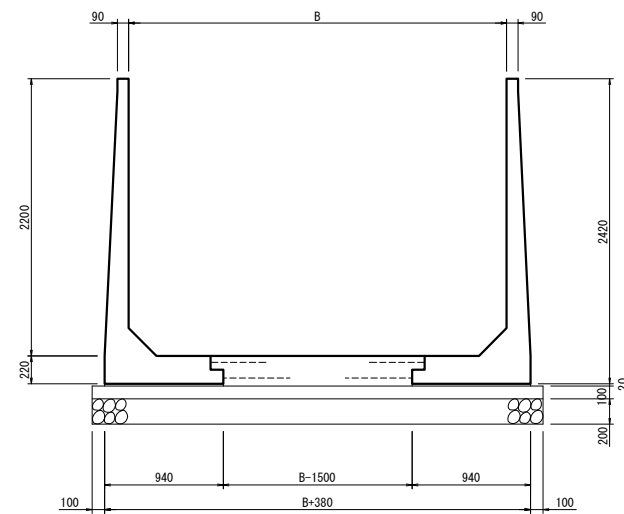

H = 2300

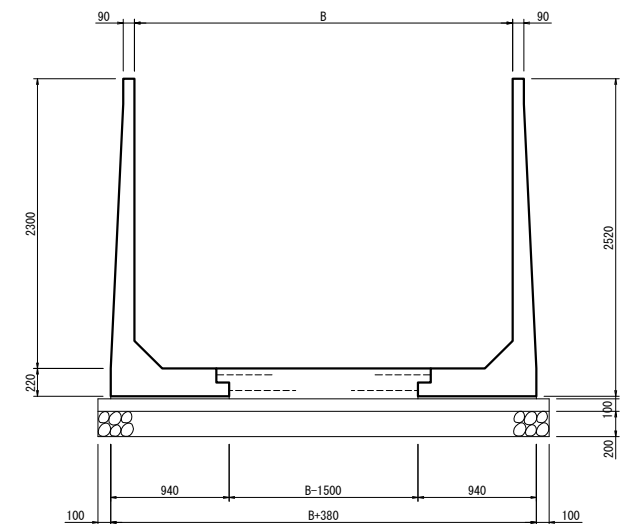

工事名	
図面名	
年月日	
尺度	図面番号
会社名	
事務所名	

L型水路

H = 2400

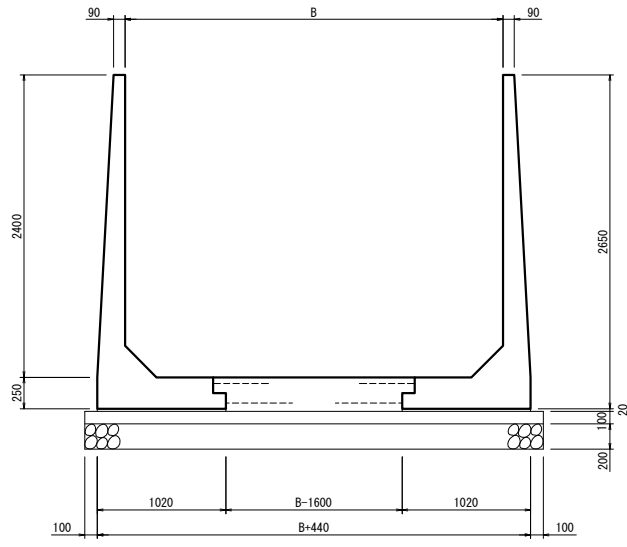

H = 2500

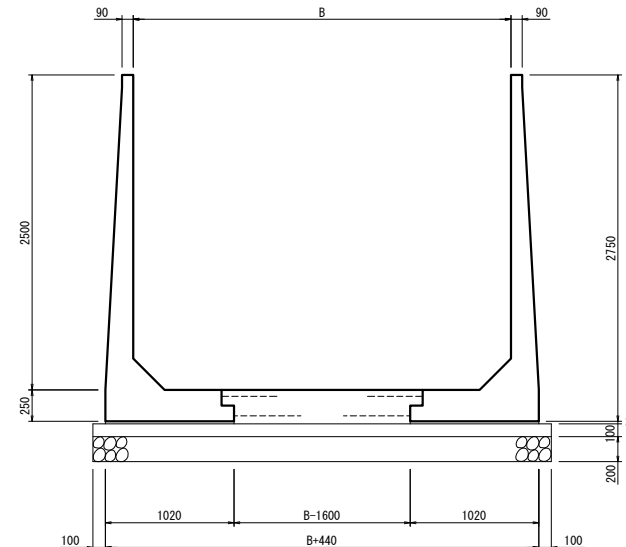

H = 2600

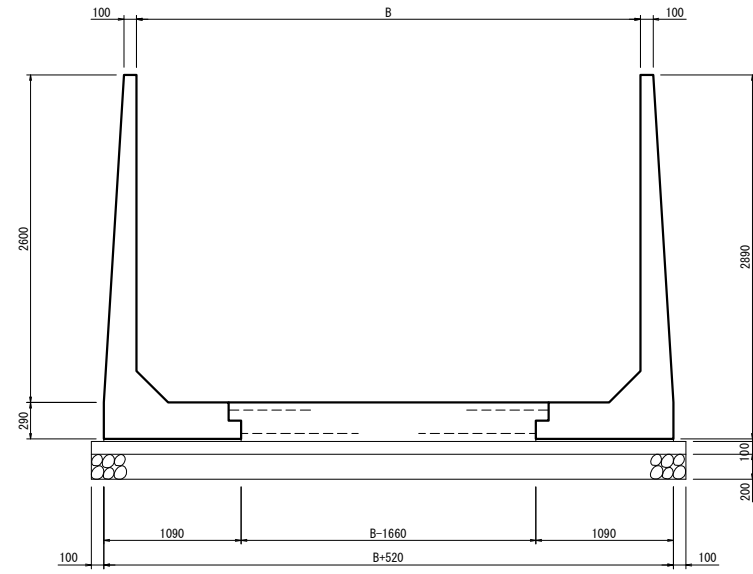

H = 2700

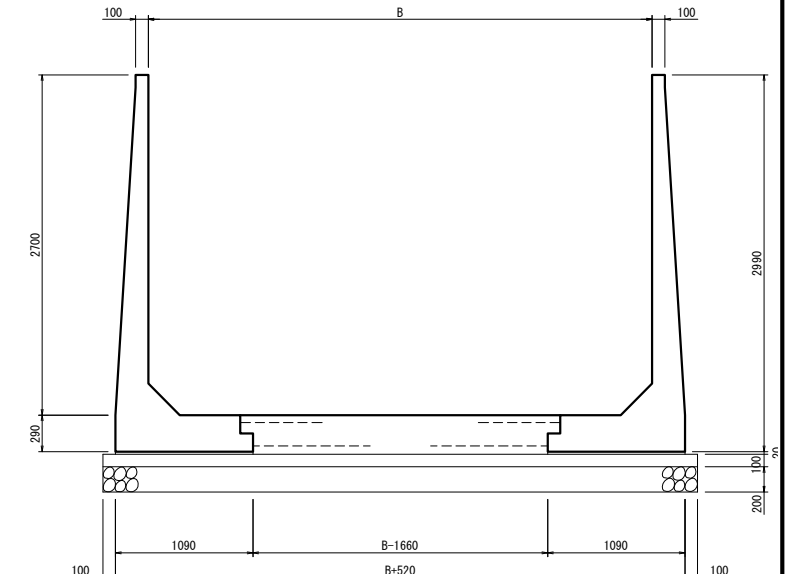

H = 2800

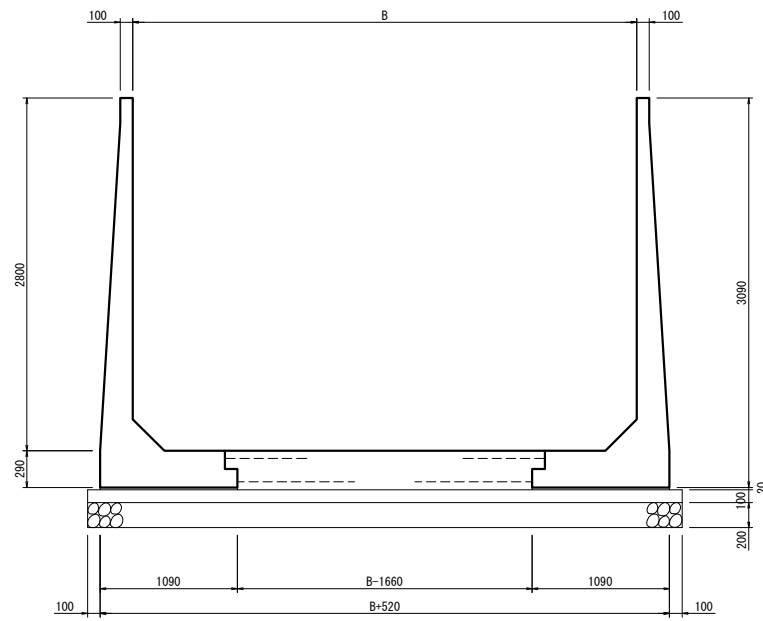

H = 2900

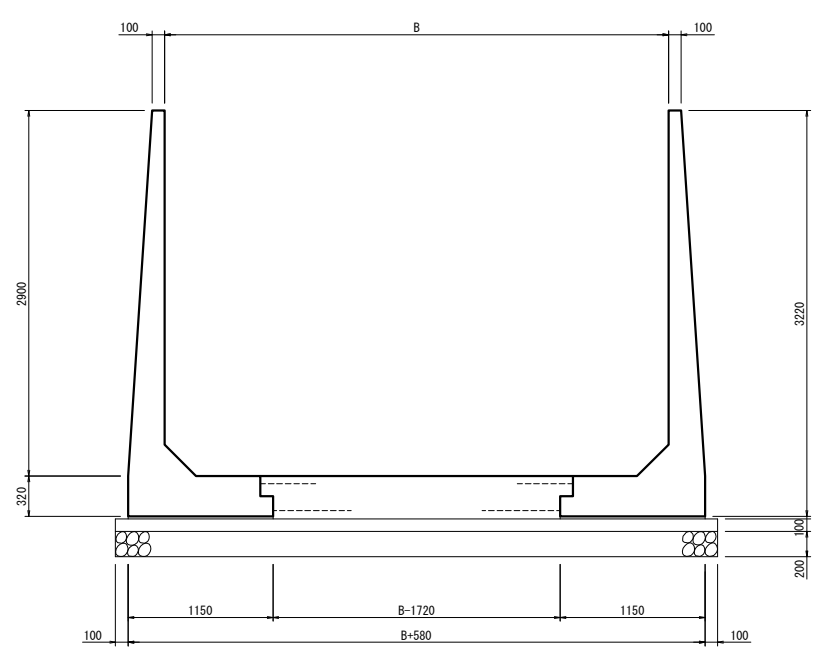

H = 3000

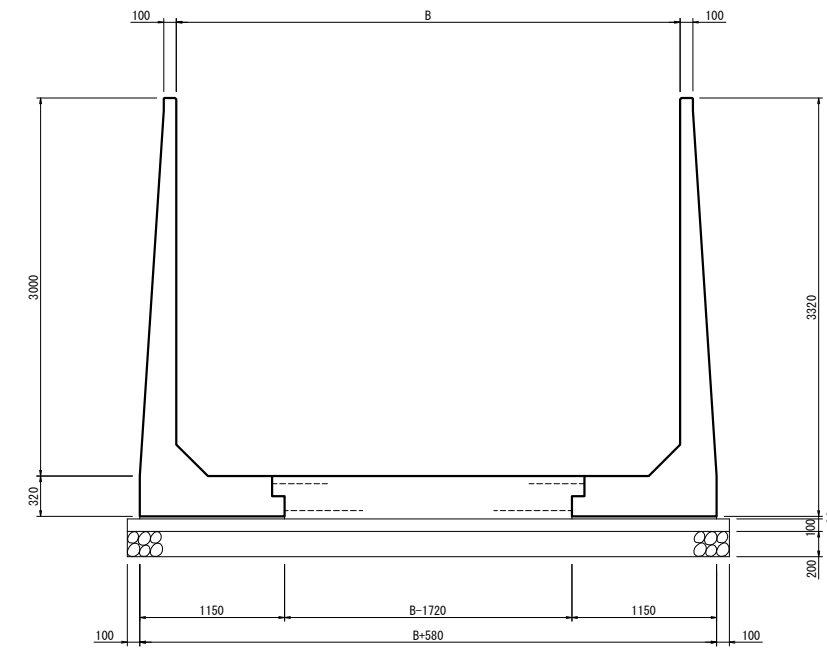

H = 900

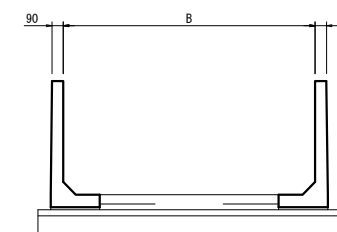

※ H=900以下は、H=900の天端をカットして、使用して下さい。

工事名	
図面名	
年月日	
尺度	図面番号
会社名	
事務所名	