

組立柵渠 (枠・板) S = 1 : 100

H = 600

300 × 600

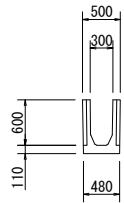

400 × 600

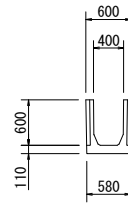

500 × 600

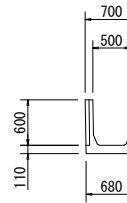

600 × 600

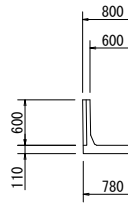

700 × 600

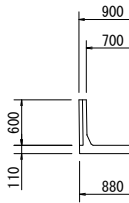

800 × 600

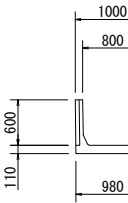

900 × 600

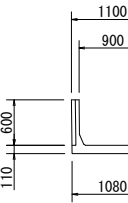

1000 × 600

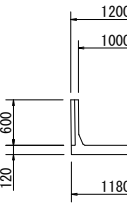

1100 × 600

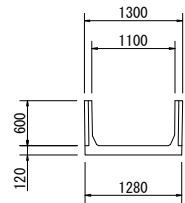

1200 × 600

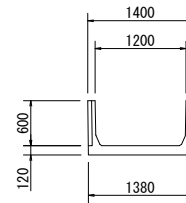

1300 × 600

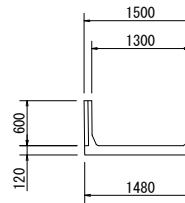

1400 × 600

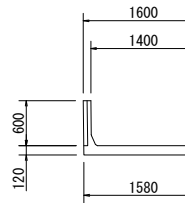

1500 × 600

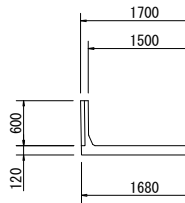

1600 × 600

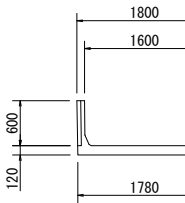

1700 × 600

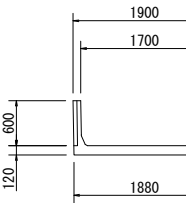

1800 × 600

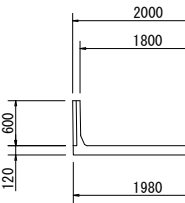

2000 × 600

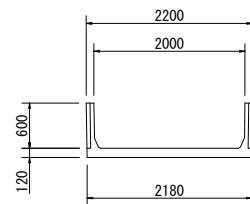

2500 × 600

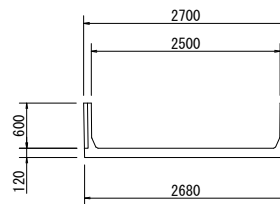

3000 × 600

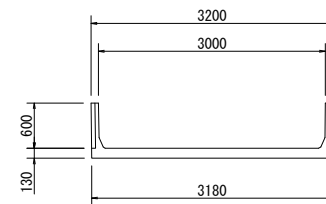

H=600一枚板

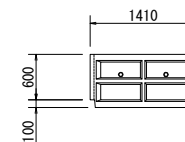

H=600分割板

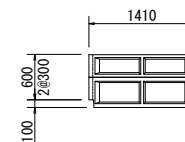

組立柵渠 (枠・板) S = 1 : 100 H = 1000

1000 × 1000

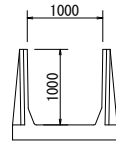

1500 × 1000

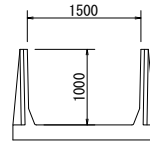

2000 × 1000

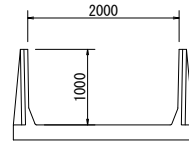

2500 × 1000

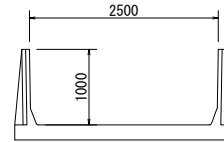

H=1000一枚板

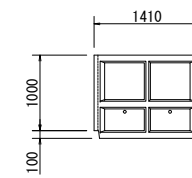

H=1000分割板

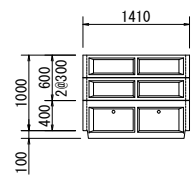

3000 × 1000

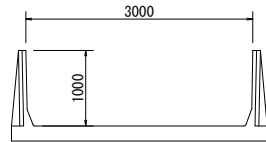

3500 × 1000

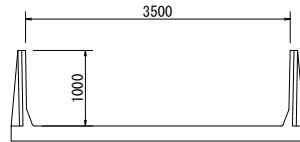

4000 × 1000

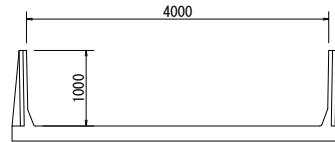

4500 × 1000

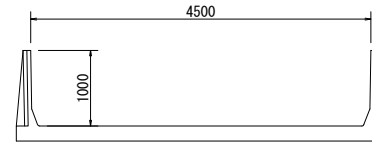

5000 × 1000

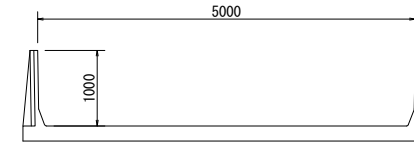

5500 × 1000

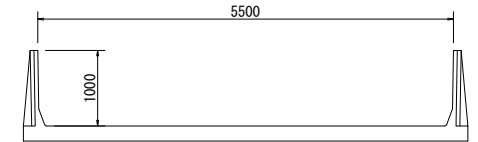

6000 × 1000

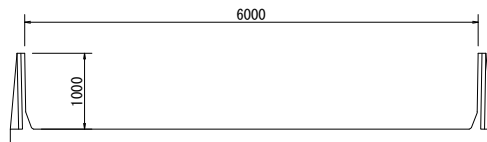

6500 × 1000

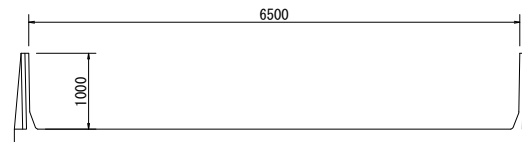

7000 × 1000

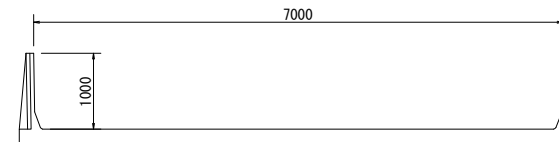

平面図

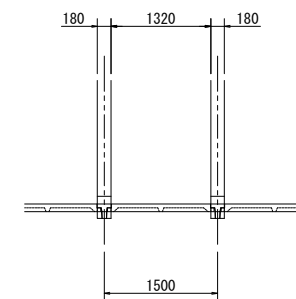

側面図

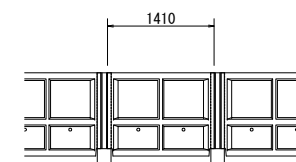

組立柵渠 (枠・板) S = 1 : 100

H = 1200

1000 × 1200

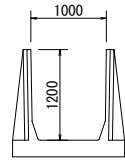

1500 × 1200

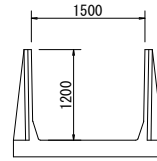

2000 × 1200

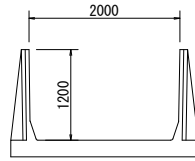

2500 × 1200

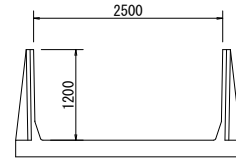

H=1200一枚板

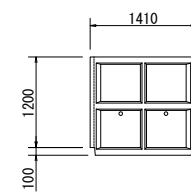

H=1200分割板

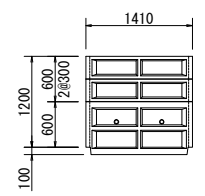

3000 × 1200

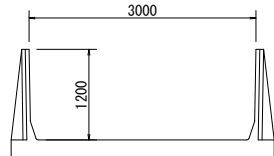

3500 × 1200

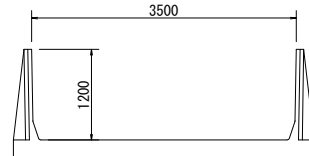

4000 × 1200

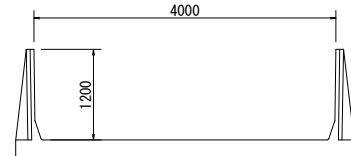

4500 × 1200

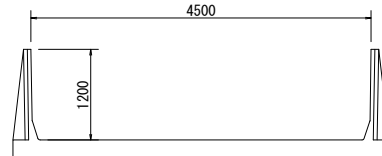

5000 × 1200

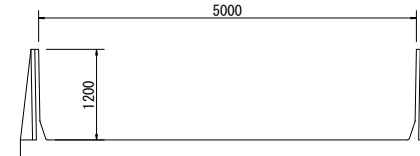

5500 × 1200

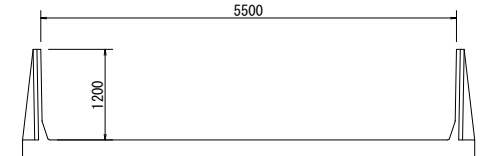

6000 × 1200

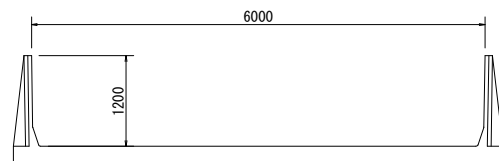

6500 × 1200

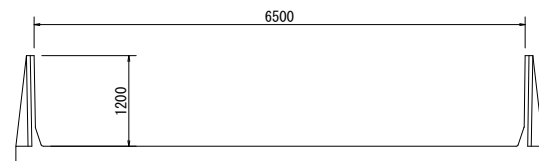

7000 × 1200

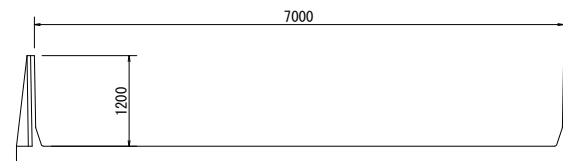

平面図

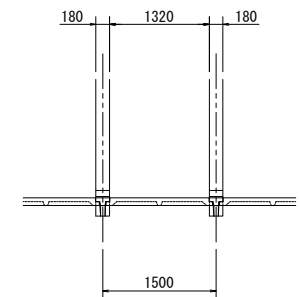

側面図

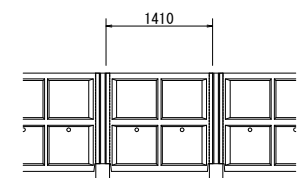

組立柵渠 (枠・板) S = 1 : 100

H = 1500

1000 × 1500

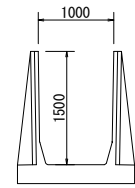

1500 × 1500

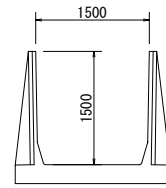

2000 × 1500

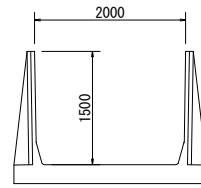

2500 × 1500

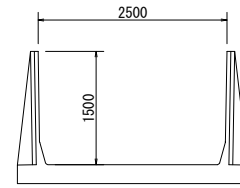

H=1500一枚板

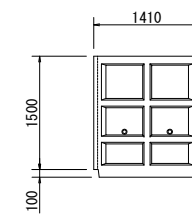

H=1500分割板

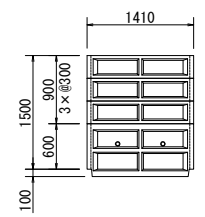

3000 × 1500

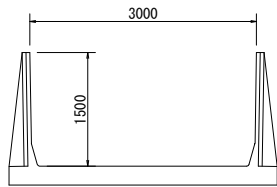

3500 × 1500

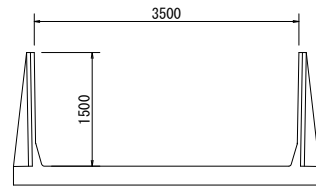

4000 × 1500

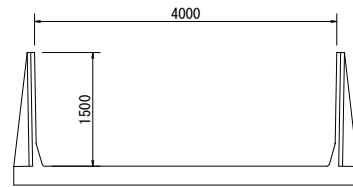

4500 × 1500

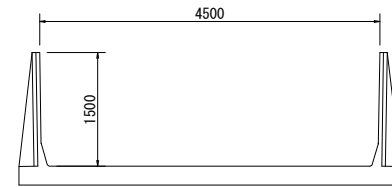

5000 × 1500

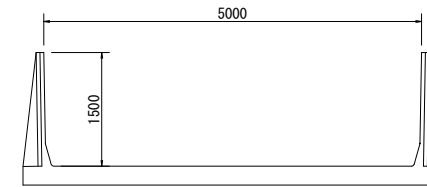

5500 × 1500

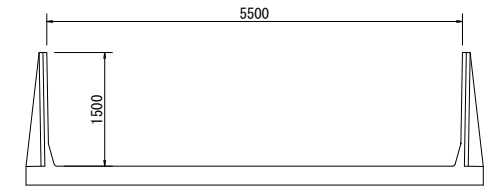

6000 × 1500

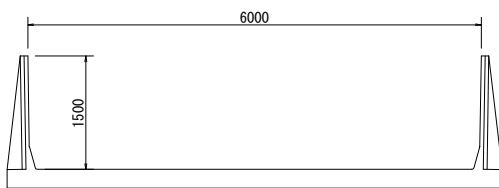

6500 × 1500

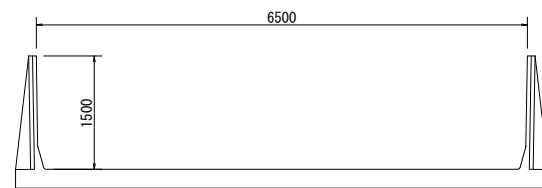

7000 × 1500

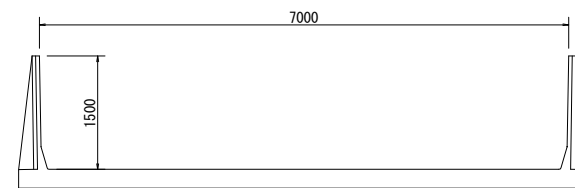

平面図

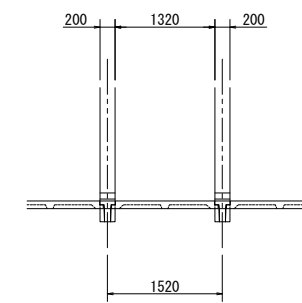

側面図

